

Sound Reinforcement Monitor

MAIN APPLICATIONS

- Band P.A.
- Personal monitor
- Small theatres
- Auditoriums
- Piano bar
- DJ
- Stage monitor
- Conference rooms
- Fixed installations in live clubs
- Pubs
- Gyms

MAIN FEATURES

- 2-way passive sound reinforcement system
- 12" custom woofer with 2" coil
- 1" high frequency driver with 1" coil
- 300W RMS recommended amplifier
- 150W long term power
- 600W short term power IEC 268-5
- 2 x M10 suspension points
- Internal passive crossover filter
- Input panel with 2 x Speakon NL4



DESCRIPTION

The FBT J 12 series speakers feature lightweight, yet rugged gas-injected molded polypropylene cabinet construction. Available in a black finish the FBT J 12 series speakers modern cabinet appearance provides fixed installations with an elegant design that blends into any decor. With the use of optional accessories the FBT J 12 speakers can be mounted on mic stands for many nearfield monitor applications, live sound and as a studio monitor. The FBT J 12 is of two-way design incorporating a 12" low-frequency woofer and 1" HF custom driver. Cabinet dispersion is 90°H x 60°V allowing for wide pattern coverage. The internal crossover is at a fixed frequency of 2kHz. With a frequency range of 55Hz - 20kHz the FBT J 12 speakers provide high-fidelity sound for both speech and music applications with a maximum SPL of 127dB. A front face steel grille protects the speaker from external damage. Ideal for fixed installations the FBT J 12 speaker system has an impedance of 8 Ohm. The two M10 fly points built into the cabinets along with the optional mounting brackets allow the FBT J 12 speakers to be surface mounted on walls or ceiling. For portable or fixed use the FBT J 12 speakers can be mounted on mic stands by using the optional adapters for vertical mounting. Rear panel connections feature 2 x Neutrik Speakon NL4.

TECHNICAL SPECIFICATIONS

GENERAL

Configuration	way	2
Low frequency woofer	inch	12 - 2 coil
High frequency driver	inch	1 - 1 coil

ACOUSTIC SPEC.

Frequency response	(@-6dB)	55Hz - 20kHz
Crossover frequency	kHz	2
Sensitivity (@1W, 1m)	dB	98
MAX SPL (cont/peak)	dB	123 / 127
Dispersion	H x V	90° x 60°
Recommended HP filter	Hz - dB /oct.	45 - 24

INPUTS & OUTPUTS

Input connectors		2x Speakon NLA4MD-V IN & LINK
------------------	--	-------------------------------

AMPLIFIER

Recommended amplifier	W RMS	300
Long term power	W	150
Short term power (IEC 268-5)	W	600
Nominal impedance	Ohm	8

MECHANICAL SPEC.

Material		Polypropylene
Net dimensions (WxHxD)	mm inch	410 x 663 x 387 16.14 x 26.1 x 15.23
Transport dimensions (WxHxD)	mm inch	495 x 755 x 475 19.49 x 29.69 x 18.70
Net weight	kg lb	14.80 32.62
Transport weight	kg lb	17.20 37.91

DIMENSIONAL DRAWING

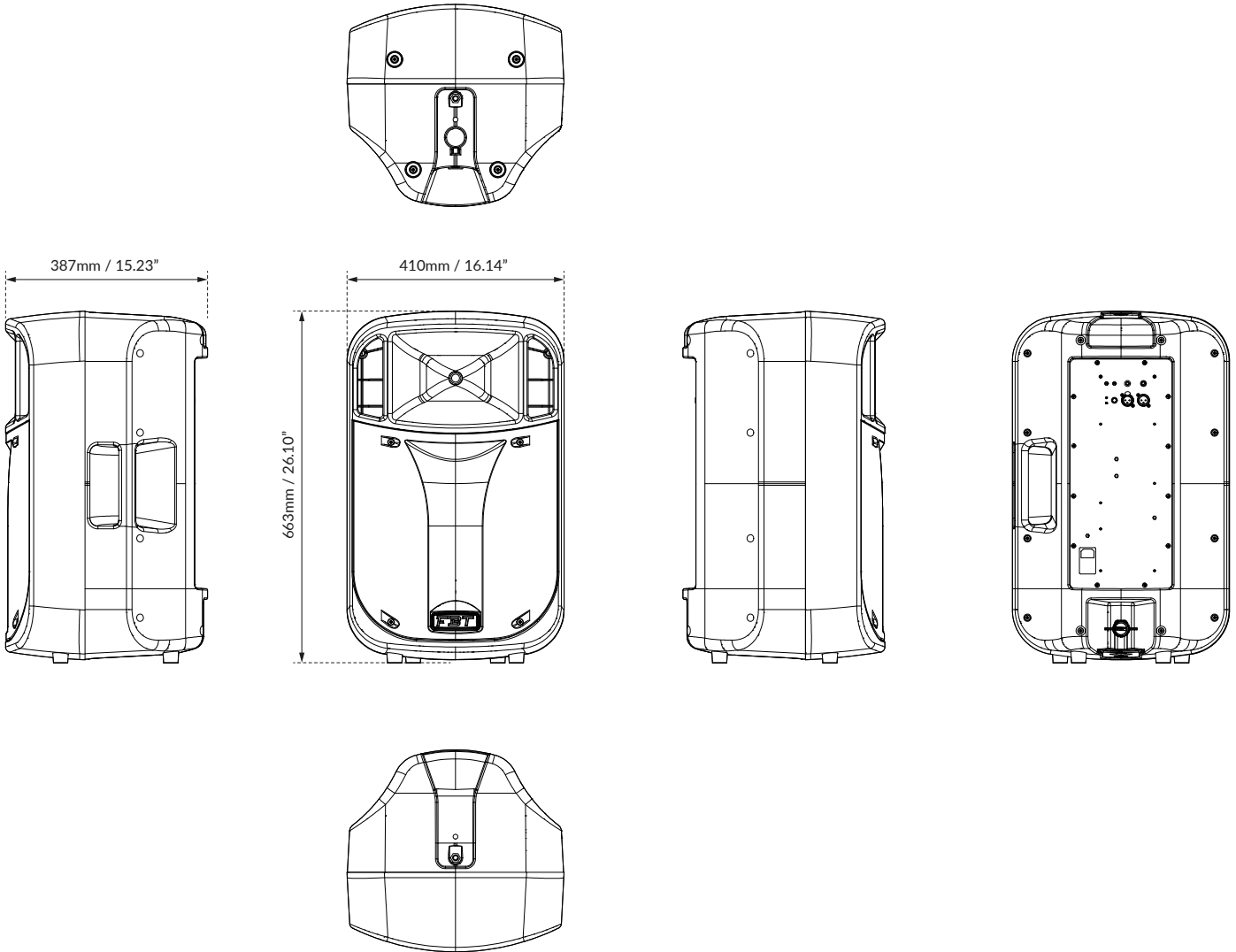

CONTROL PANEL

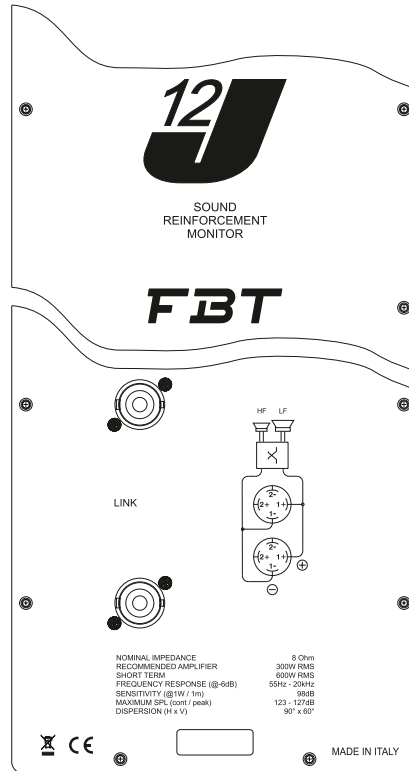

ACCESSORIES

BOX-112

Horizontal Wall Bracket

Code: 18602

675 x 70 x 285mm
 26.57 x 2.75 x 11.22inch
 2 kg / 4.40 lb

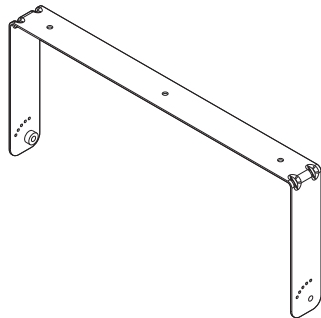

MSA 300BK

Speaker Stand

Code: 39326

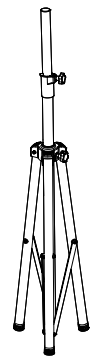

MSA 220BKS

Adjustable Stand for Sub-Sat Connection

Code: 39330

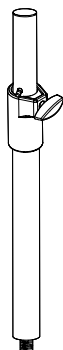

DIAGRAMS

Horizontal polar diagrams

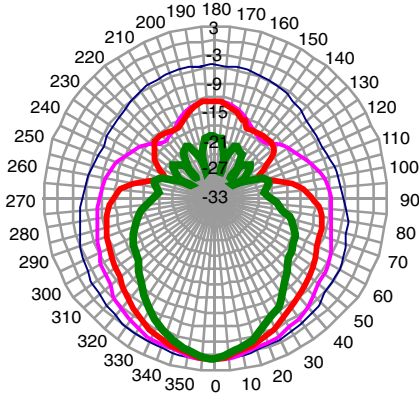

Horizontal polar diagrams

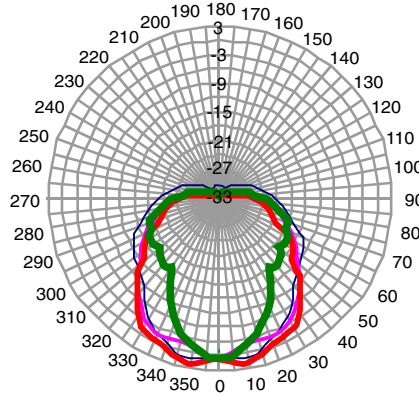

Vertical polar diagrams

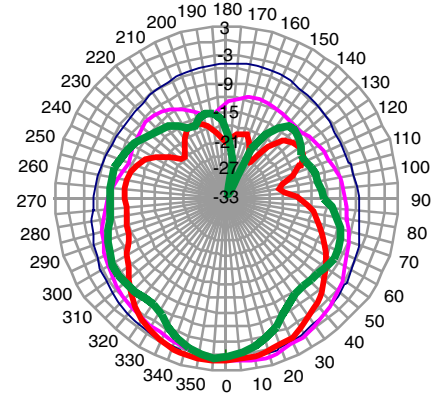

Vertical polar diagrams

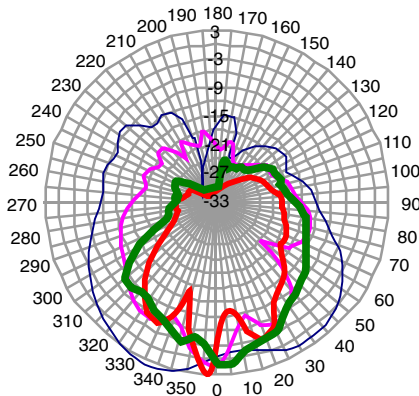
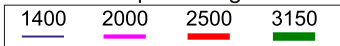

Vertical polar diagrams

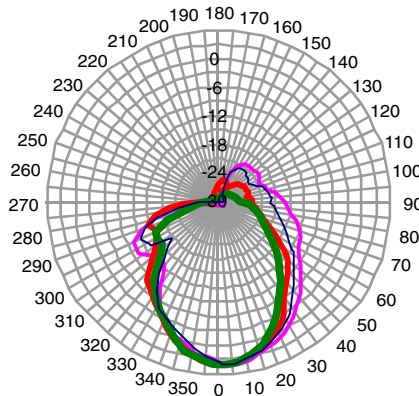
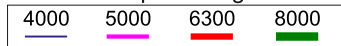

Vertical polar diagrams

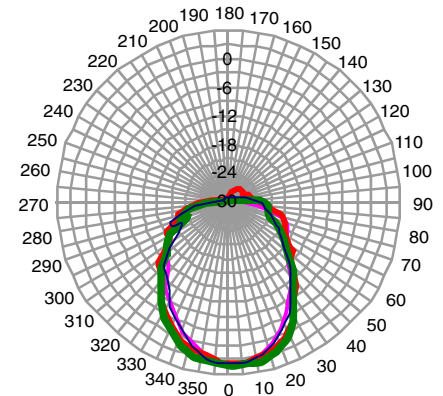

dB SPL **FREQUENCY RESPONSE**

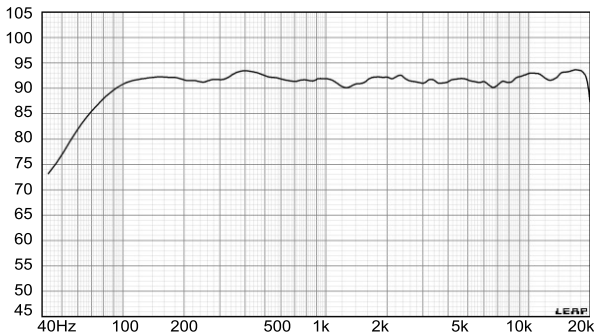

HORIZONTAL BEAMWIDTH (-6dB)

