

APPLICATIONS

- Live Sound P.A. System or Live SoundMonitor, D.J. System
- School & Corporate Audio Visual Sound Reinforcement
- Background Music/Announcement: Restaurants, Pubs
- Transportation Terminals, Clubs, Auditoriums, Theatres
- Gyms, Houses of Worship

FEATURES

- 0,59" baltic birch plywood cabinet, internally braced to prevent undesired resonance and vibrations
- 15" B&C custom neodymium woofer
- B&C HF compression driver with 1.4" voice coil and 1" exit
- 80° x 50° constant directivity rotatable horn
- Control panel with ground-lift, XLR input & output, 2-band EQ, signal/limiter/thermal led indicator, volume control.
- Wall, ceiling, cluster, speaker stands. Optional accessories required
- Six M10 fly points
- 2 metal carrying handles
- High SPL capability: 129dB
- Completely Manufactured in Italy



PRODUCT DESCRIPTION

The FBT VERVE15A bi-amplified speaker feature 0.59" Baltic birch plywood construction, covered in a scratch & scuff resistant black finish. The FBT VERVE 15A is a two way design incorporating a 15" B&C custom neodymium woofer with 2.5" voice coil, 1" B&C compression driver with 1,4" voice coil coupled to a rotatable 80° H x 50° V horn. Thanks to the rotatable HF horns it is possible to create horizontal arrays of 2 enclosures for a total coverage of 80°. With a frequency range of 48Hz-20kHz the FBT VERVE 15A provides hi fidelity sound for both speech and music applications with a maximum SPL of 129dB. The bi-amplified FBT VERVE 15A features a 350W RMS class "G" low frequency amp and a 100W RMS class "G" high frequency amp. The control panel features a master volume control, 2-band EQ with ± 15 dB of cut-boost LF and ± 15 dB of cut-boost HF, XLR input & output, ground lift switch and signal/limiter/thermal led indicator. A front face steel grille protects the woofer from externa damage. The six M10 fly points built into the cabinet along with the optional BOX 116 mounting bracket allow the FBT VERVE 15A speakers to be surface mounted on walls or ceilings. A standard 1,38" speaker stand socket allows the FBT VERVE 15A to be mounted on speaker stands.

ELECTRICAL PERFORMANCE

System Type:	2 Way
Internal Amplifier *	cont.: 350W+100W RMS max.: 350W+100W RMS max. peak: 700W+200W RMS
Low Frequency Woofer	15" / 2.5" coil
High Frequency Driver	1" / 1.4" coil
Input Impedance	22 kOhm
Frequency Response @ -6dB	48Hz - 20kHz
Input Sensitivity	0dBu line
Maximum SPL (continuous/peak) **	123.5dB / 129dB
Dispersion	80°H x 50°V rotatable
Crossover Frequency	1.8 kHz
AC Power Requirement (continuous/peak)	350/700VA

PHYSICAL

Input Connectors	XLR with loop
Net Dimensions (WxHxD)	17" x 28,7" x 15,9"
Shipping Dimensions (WxHxD)	18,5" x 32,3" x 20,5"
Net Weight	55,11 lbs
Shipping Weight	62,17 lbs
Enclosure Material	0.59" baltic birch plywood
Grille	Steel with powder coat black paint finish
Power Cord	16,4"

* CONT. : 500ms burst, rms power on nominal speaker impedance
MAX: 2ms burst, rms power on nominal speaker impedance
MAX PEAK: based on max peak output voltage and nominal speaker impedance

** CONT. SPL: free space, based on continuous power amp rating and LF transducer average sensitivity data, 125mS time average
PEAK SPL: free space, based on max. peak power amp rating and system peak sensitivity, 10mS time average

DIAGRAMS

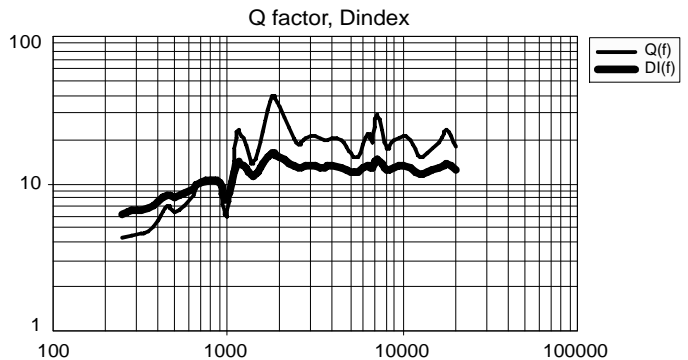
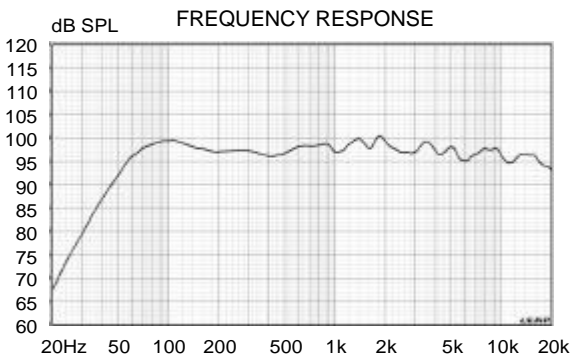
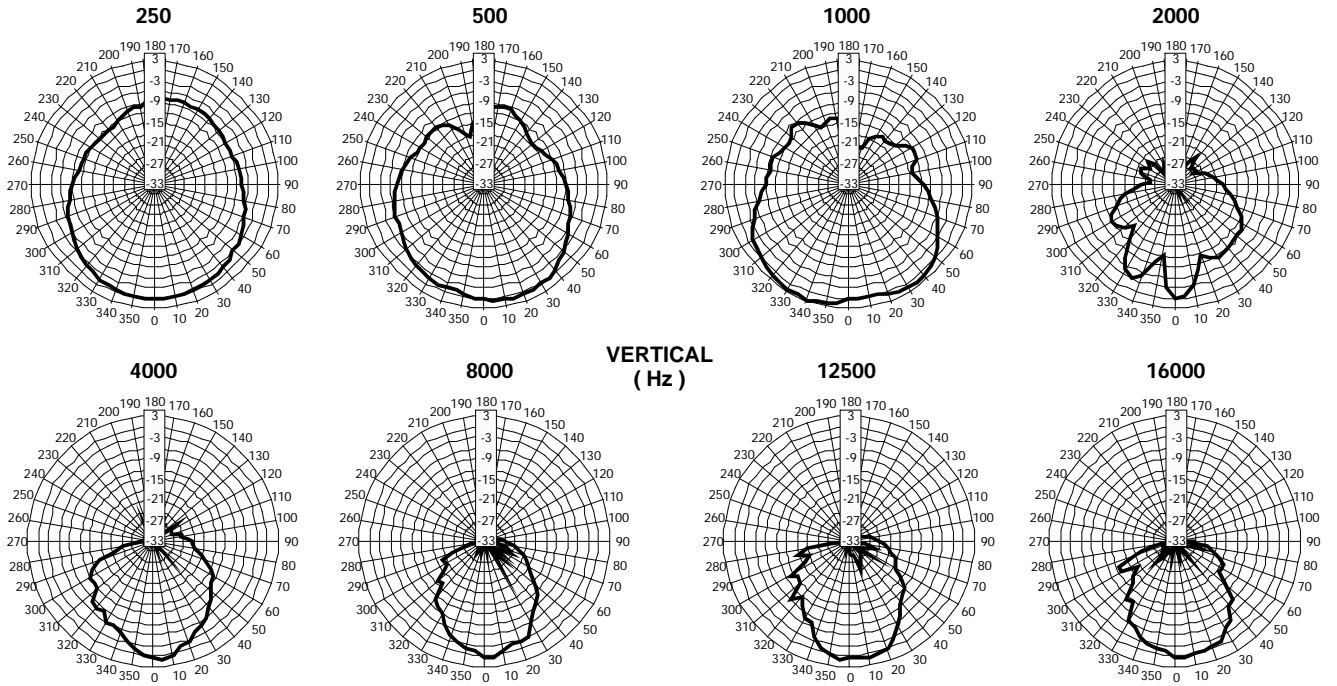
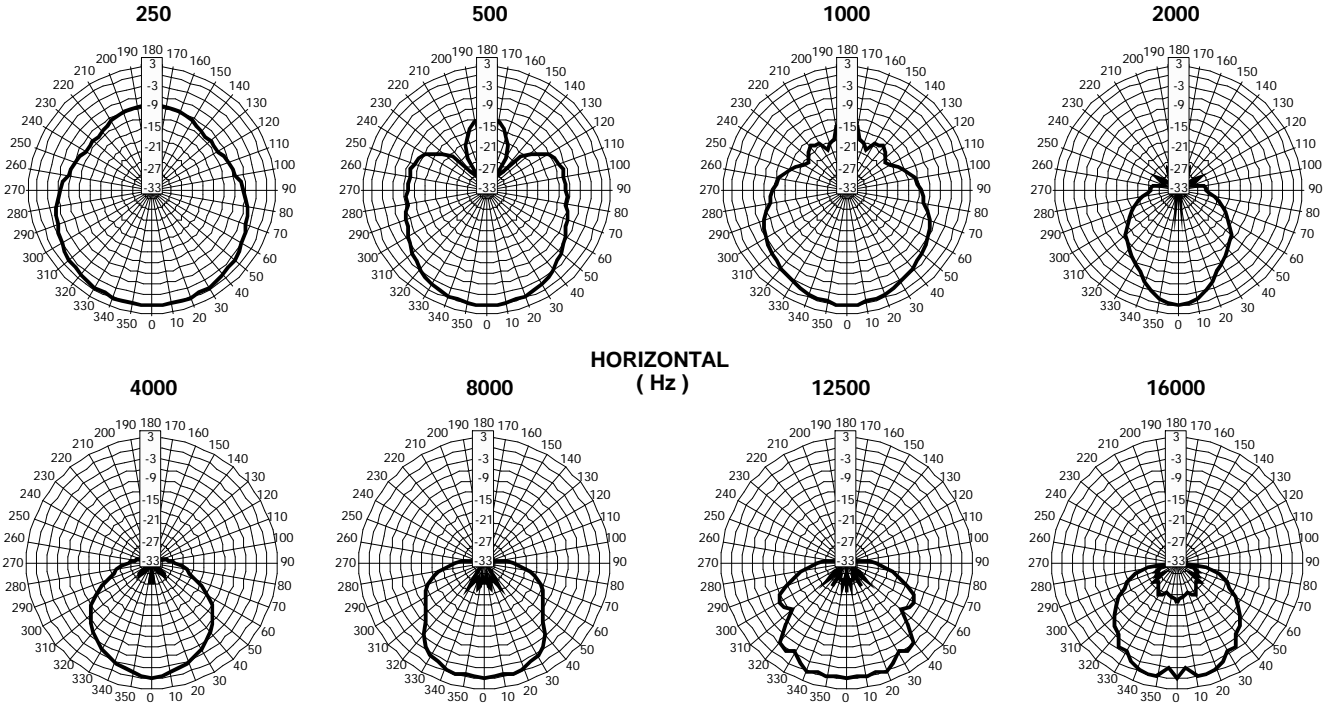

CONTROL PANEL

DIMENSION DRAWING

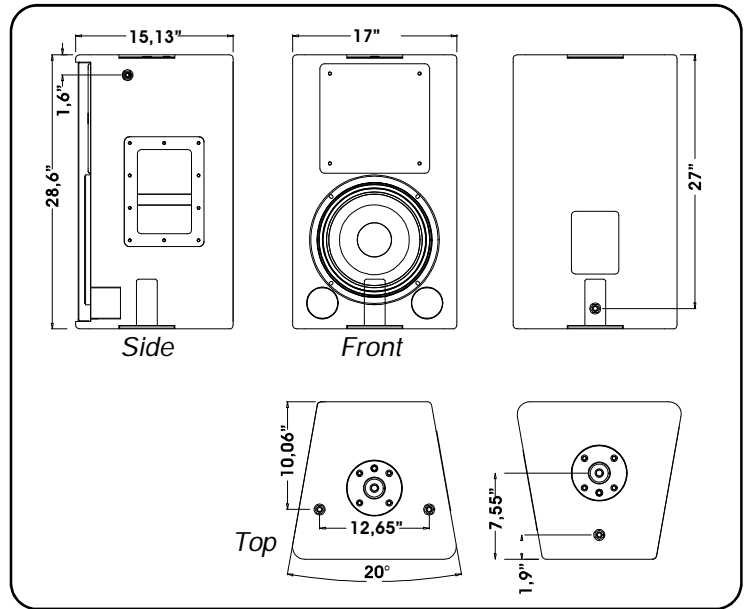
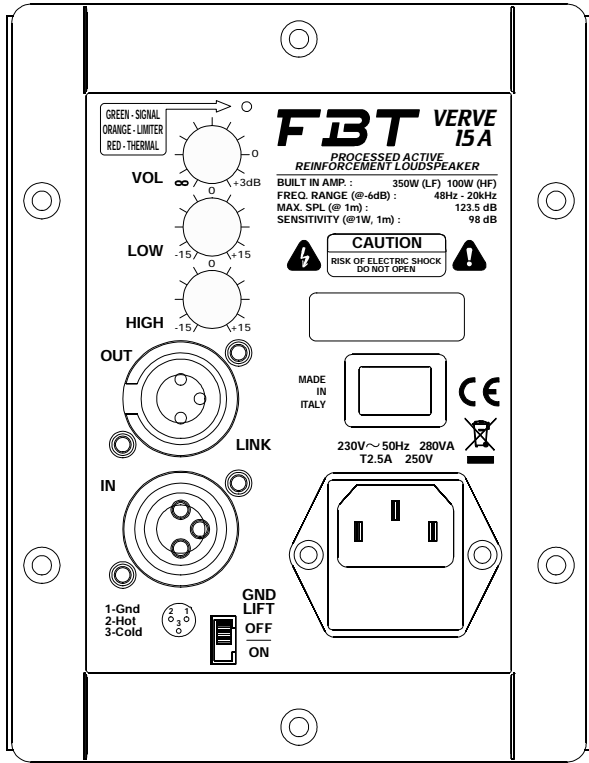

ACCESSORIES



BOX 116
Mount for horizontal wall installation

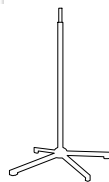

SS2
Standard speaker floor stand

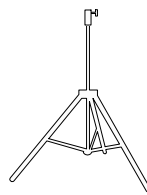

BOX 32BK
Adjustable aluminium floor stand, damped safety mechanism

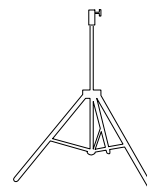

BOX 22BK
Adjustable aluminium floor stand, $\varnothing 1.38''$ with $\varnothing 1''$ adapter



BOX 52BK
Adjustable for sub-satellite speaker connection, with safety locking device

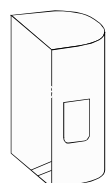

V 48
Nylon case